

SPECIFICATION

Range: **Jolly**

Design: **Caimi Lab**

SMALL TABLES WITH POWDER COATED FRAME AND HPL TOP Ø 60 cm

Codes: **2JH610-GAGR, 2JH610-GAB** height 104 cm, base Ø 50 cm, top Ø 60 cm
2JH67-GAGR, 2JH67-GAB height 72 cm, base Ø 50 cm, top Ø 60 cm
2JH65-GAGR, 2JH65-GAB height 53,5 cm, base Ø 50 cm, top Ø 60 cm

Description: small tables with a steel base ø 50 mm, 5 mm thick, silver grey epoxy-powder coating, with holes in the centre to fix the stand made of ø 50 mm silver grey epoxy-powder coated tubular steel; a circular plate in silver grey epoxy-powder coated steel fastened to the upper section of the stand by M8 screws; ø 600 mm circular top in thick 12 mm “HPL” (high pressure laminates), white or grey on the outer surfaces and black interiors, with tapered edging. The top is fastened to the steel plate using 6 x M6 zinc-plated screws. The base also has a fitting that allows it to be fastened to the floor.



2JH610-GAGR



2JH67-GAGR



2JH65-GAGR



2JH610-GAB



2JH67-GAB



2JH65-GAB



Detail of grey HPL top



Detail of white HPL top

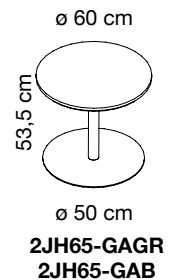
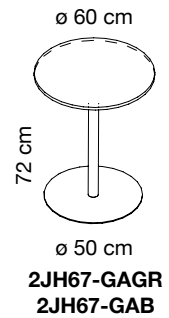
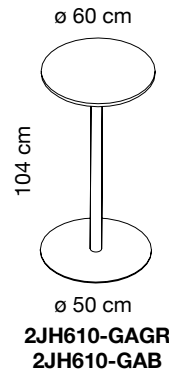

SMALL TABLES WITH POWDER COATED FRAME AND HPL TOP Ø 80 cm

Codes: **2JH810-GAGR, 2JH810-GAB** height 104,5 cm, base Ø 50 cm, top Ø 80 cm
2JH87-GAGR, 2JH87-GAB height 72,5 cm, base Ø 50 cm, top Ø 80 cm
2JH85-GAGR, 2JH85-GAB height 54 cm, base Ø 50 cm, top Ø 80 cm

Description: small tables with a steel base ø 500 mm, 10 mm thick, silver grey epoxy-powder coating, with holes in the centre to fix the stand made of ø 50 mm silver grey epoxy-powder coated tubular steel; a circular plate in silver grey epoxy-powder coated steel fastened to the upper section of the stand by M8 screws; ø 800 mm circular top in thick 12 mm "HPL" (high pressure laminates), white or grey on the outer surfaces and black interiors, with tapered edging. The top is fastened to the steel plate using 6 x M6 zinc-plated screws.
 The base also has a fitting that allows it to be fastened to the floor.



2JH810-GAGR



2JH87-GAGR



2JH85-GAGR



2JH810-GAB



2JH87-GAB



2JH85-GAB



Detail of grey HPL top



Detail of white HPL top

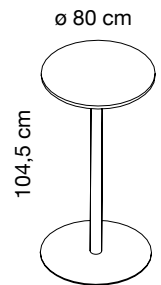

104,5 cm

ø 80 cm

ø 50 cm

**2JH810-GAGR
2JH810-GAB**

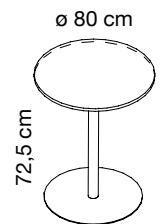

72,5 cm

ø 80 cm

ø 50 cm

**2JH87-GAGR
2JH87-GAB**

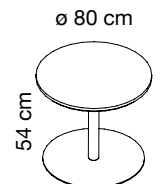

54 cm

ø 80 cm

ø 50 cm

**2JH85-GAGR
2JH85-GAB**

SMALL TABLES WITH POWDER COATED FRAME AND SQUARE HPL TOP L 70 cm

Codes: **2JH710-GAGR, 2JH710-GAB** height 104,5 cm, base Ø 50 cm, top L 70 cm
2JH77-GAGR, 2JH77-GAB height 72,5 cm, base Ø 50 cm, top L 70 cm
2JH75-GAGR, 2JH75-GAB height 54 cm, base Ø 50 cm, top L 70 cm

Description: small tables with a steel base ø 500 mm, 10 mm thick, silver grey epoxy-powder coating, with holes in the centre to fix the stand made of ø 50 mm silver grey epoxy-powder coated tubular steel; a circular plate in silver grey epoxy-powder coated steel fastened to the upper section of the stand by M8 screws; ø 800 mm circular top in thick 12 mm "HPL" (high pressure laminates), white or grey on the outer surfaces and black interiors, with tapered edging. The top is fastened to the steel plate using 6 x M6 zinc-plated screws.

The base also has a fitting that allows it to be fastened to the floor.



2JH710-GAGR



2JH77-GAGR



2JH75-GAGR



2JH710-GAB



2JH77-GAB



2JH75-GAB



Detail of grey HPL top



Detail of white HPL top

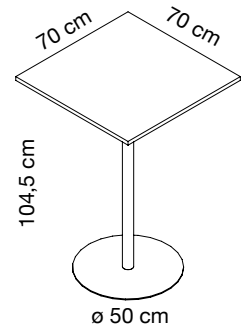

**2JH710-GAGR
2JH710-GAB**

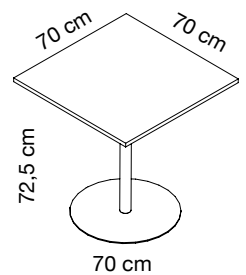

**2JH77-GAGR
2JH77-GAB**

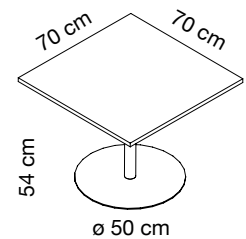

**2JH75-GAGR
2JH75-GAB**

SMALL TABLES WITH CHROME-PLATED FRAME AND HPL TOP Ø 60 cm

Codes: **2JH610-IGR, 2JH610-IB**
2JH67-IGR, 2JH67-IB
2JH65-IGR, 2JH65-IB

height 104 cm, base Ø 50 cm, top Ø 60 cm
 height 72 cm, base Ø 50 cm, top Ø 60 cm
 height 53,5 cm, base Ø 50 cm, top Ø 60 cm

Description: small tables with a steel base ø 500 mm, 5 mm thick, silver grey epoxy-powder coating, covered in stainless steel, with holes in the centre to fix the stand made of ø 50 mm chrome-plated tubular steel; a circular plate in silver grey epoxy-powder coated steel fastened to the upper section of the stand by M8 screws; ø 600 mm circular top in thick 12 mm "HPL" (high pressure laminates), white or grey on the outer surfaces and black interiors, with tapered edging. The top is fastened to the steel plate using 6 x M6 zinc-plated screws. The base also has a fitting that allows it to be fastened to the floor.



2JH610-IGR



2JH67-IGR



2JH65-IGR



2JH610-IB



2JH67-IB



2JH65-IB



Detail of grey HPL top



Detail of white HPL top

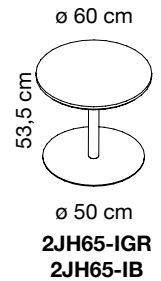
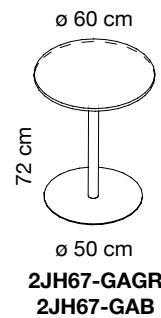
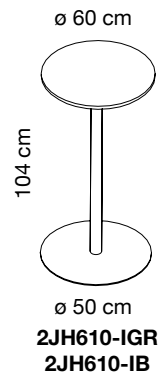

SMALL TABLES WITH CHROME-PLATED FRAME AND HPL TOP Ø 80 cm

Codes: **2JH810-IGR, 2JH810-IB**
2JH87-IGR, 2JH87-IB
2JH85-IGR, 2JH85-IB

height 104 cm, base Ø 50 cm, top Ø 80 cm
 height 72 cm, base Ø 50 cm, top Ø 80 cm
 height 53,5 cm, base Ø 50 cm, top Ø 80 cm

Description: small tables with a steel base ø 500 mm, 10 mm thick, silver grey epoxy-powder coating, covered in stainless steel, with holes in the centre to fix the stand made of ø 50 mm chrome-plated tubular steel; a circular plate in silver grey epoxy-powder coated steel fastened to the upper section of the stand by M8 screws; ø 800 mm circular top in thick 12 mm "HPL" (high pressure laminates), white or grey on the outer surfaces and black interiors, with tapered edging. The top is fastened to the steel plate using 6 x M6 zinc-plated screws. The base also has a fitting that allows it to be fastened to the floor.



2JH810-IGR



2JH87-IGR



2JH85-IGR



2JH810-IB



2JH87-IB



2JH85-IB



Detail of grey HPL top



Detail of white HPL top

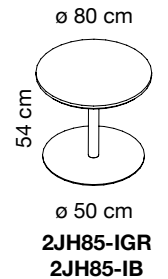
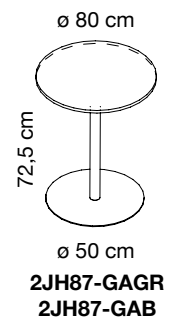
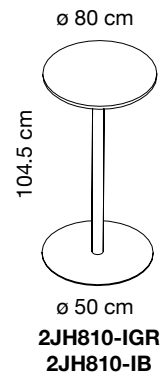

SMALL TABLES WITH CHROME-PLATED FRAME AND SQUARE HPL TOP L 70 cm

- 2JQH710-IGR, 2JQH710-IB** height 104 cm, base Ø 50 cm, top L 70 cm
- 2JQH77-IGR, 2JQH77-IB** height 72 cm, base Ø 50 cm, top L 70 cm
- 2JQH75-IGR, 2JQH75-IB** height 53,5 cm, base Ø 50 cm, top L 70 cm

Description: small tables with a steel base ø 500 mm, 10 mm thick, silver grey epoxy-powder coating, covered in stainless steel, with holes in the centre to fix the stand made of ø 50 mm chrome-plated tubular steel; a circular plate in silver grey epoxy-powder coated steel fastened to the upper section of the stand by M8 screws; ø 800 mm circular top in thick 12 mm "HPL" (high pressure laminates), white or grey on the outer surfaces and black interiors, with tapered edging. The top is fastened to the steel plate using 6 x M6 zinc-plated screws. The base also has a fitting that allows it to be fastened to the floor.



2JQH710-IGR



2JQH77-IGR



2JQH75-IGR



2JQH710-IB



2JQH77-IB



2JQH75-IB



Detail of grey HPL top



Detail of white HPL top

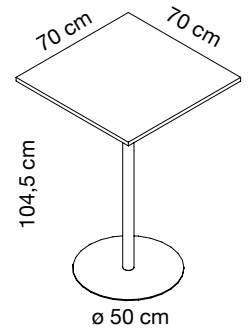

**2JQH710-GAGR
2JQH710-GAB**

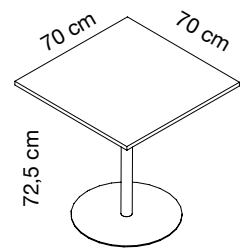

**2JQH77-GAGR
2JQH77-GAB**

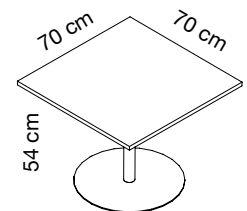

**2JQH75-IGR
2JQH75-IB**

POWDER COATED FRAME FOR HPL TOP Ø 60 cm

Codes: **2SJ610-GA** height 102,5 cm, base Ø 50 cm
2SJ67-GA height 70,5 cm, base Ø 50 cm
2SJ65-GA height 52 cm, base Ø 50 cm

Description: frame composed of a steel base ø 500 mm, 5 mm thick, silver grey epoxy-powder coating, with holes in the centre to fix the stand made of ø 50 mm silver grey epoxy-powder coated tubular steel. The base also has a fitting that allows it to be fastened to the floor. Top fixing plates not included.

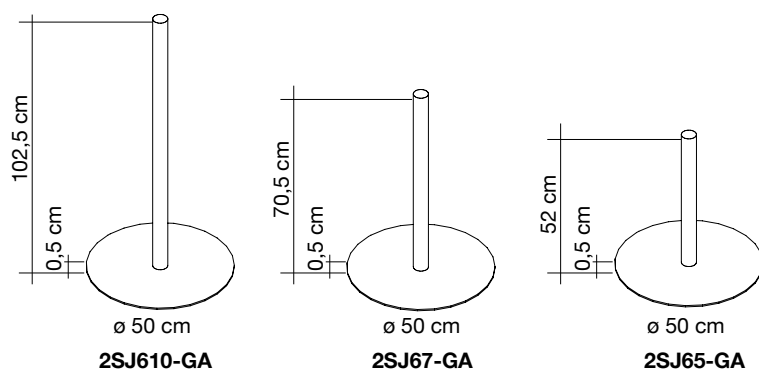

Frames for tables code: **2JH610-GAGR, 2JH610-GAB, 2JH67-GAGR, 2JH67-GAB, 2JH65-GAGR, 2JH65-GAB**

POWDER COATED FRAME FOR HPL TOP Ø 60 / 80 cm OR SQUARE L 70 cm

Codes: **2SJ810-GA** height 103 cm, base Ø 50 cm
2SJ87-GA height 71 cm, base Ø 50 cm
2SJ85-GA height 52,5 cm, base Ø 50 cm

Description: frame composed of a steel base ø 500 mm, 10 mm thick, silver grey epoxy-powder coating, with holes in the centre to fix the stand made of ø 50 mm silver grey epoxy-powder coated tubular steel. The base also has a fitting that allows it to be fastened to the floor. Top fixing plates not included.

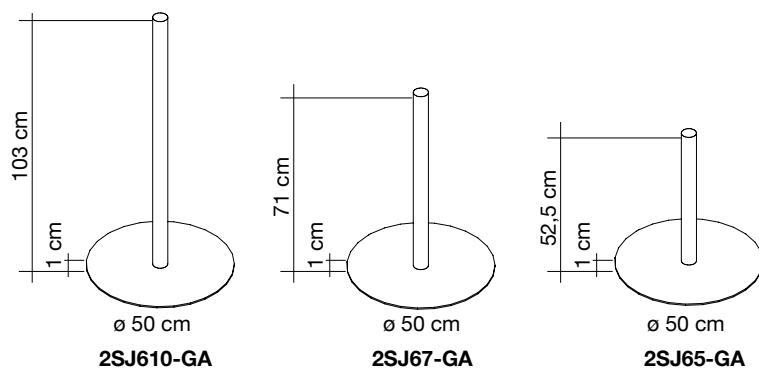

Frames for tables code: **2JH610-GAGR, 2JH610-GAB, 2JH67-GAGR, 2JH67-GAB, 2JH65-GAGR, 2JH65-GAB, 2JH810-GAGR, 2JH810-GAB, 2JH87-GAGR, 2JH87-GAB, 2JH85-GAGR, 2JH85-GAB, 2JQH710-GAGR, 2JQH710-GAB, 2JQH77-GAGR, 2JQH77-GAB, 2JQH75-GAGR, 2JQH75-GAB**

CHROME-PLATED FRAME FOR HPL TOP Ø 60 cm

Codes: **2SJ610-I** height 102,5 cm, base Ø 50 cm
2SJ67-I height 70,5 cm, base Ø 50 cm
2SJ65-I height 52 cm, base Ø 50 cm

Description: frame composed of a steel base ø 500 mm, 5 mm thick, silver grey epoxy-powder coating, covered in stainless steel, with holes in the centre to fix the stand made of ø 50 mm chrome-plated tubular steel.

The base also has a fitting that allows it to be fastened to the floor.
 Top fixing plates not included.

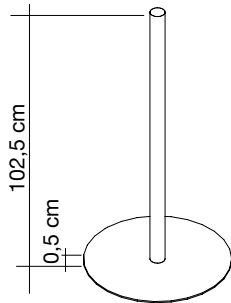

ø 50 cm
2SJ610-I

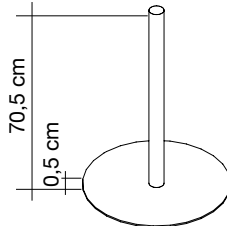

ø 50 cm
2SJ67-I

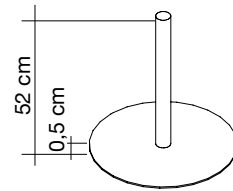

ø 50 cm
2SJ65-I

Frames for tables code: **2JH610-IGR, 2JH610-IB, 2JH67-IGR, 2JH67-IB, 2JH65-IGR, 2JH65-IB**

CHROME-PLATED FRAME FOR HPL TOP Ø 60 / 80 cm OR SQUARE L 70 cm

Codes: **2SJ810-I** height 103 cm, base Ø 50 cm
2SJ87-I height 71 cm, base Ø 50 cm
2SJ85-I height 52,5 cm, base Ø 50 cm

Description: frame composed of a steel base ø 500 mm, 10 mm thick, silver grey epoxy-powder coating, covered in stainless steel, with holes in the centre to fix the stand made of ø 50 mm chrome-plated tubular steel.

The base also has a fitting that allows it to be fastened to the floor.
 Top fixing plates not included.

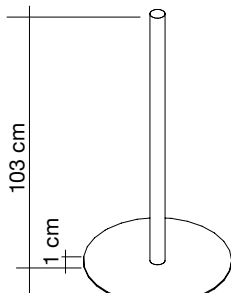

ø 50 cm
2SJ810-I

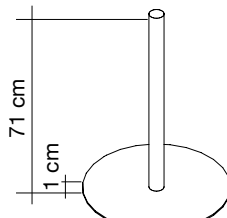

ø 50 cm
2SJ87-I

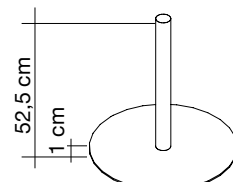

ø 50 cm
2SJ85-I

Frames for tables code: **2JH610-IGR, 2JH610-IB, 2JH67-IGR, 2JH67-IB, 2JH65-IGR, 2JH65-IB, 2JH810-IGR, 2JH810-IB, 2JH87-IGR, 2JH87-IB, 2JH85-IGR, 2JH85-IB, 2JQH710-IGR, 2JQH710-IB, 2JQH77-IGR, 2JQH77-IB, 2JQH75-IGR, 2JQH75-IB**

TOP FIXING PLATES

Code: **2FJH30-GA**

Description: plate for HPL top fixing carried out in silver grey epoxy-powder coated steel to be fastened to the upper section of the stand by M8 screws. The top is fastened to the steel plate using screws.

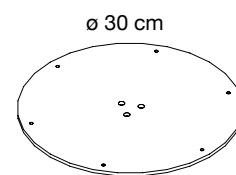

2FJV100-I
Plate to fix HPL tops